

P **PROLIFT**
ELEVATOR
BMP-364

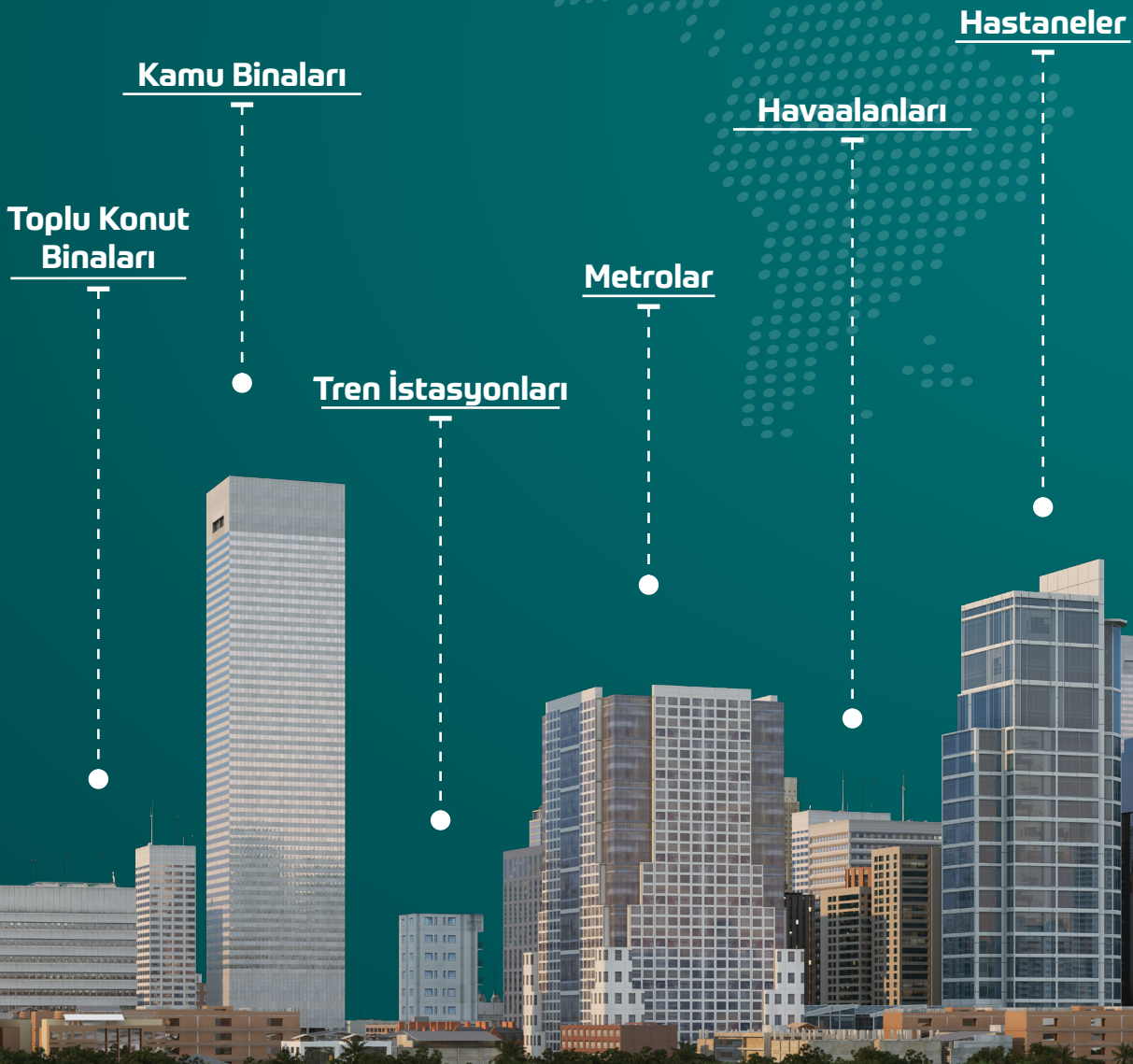

ProManner ProService Prolift

BMP-364 nerelerde ?





Alışveriş Merkezleri

Oteller

Ofisler

Endüstriyel İşyerleri

Villalar



İÇİNDEKİLER

▶ HAKKIMIZDA	06 - 07
▶ BMP-364	08 - 09
▶ ÖZEL ÇÖZÜMLER	10 - 11
▶ GÜVEN VE GÜVENİLİRLİK	12 - 13
▶ MODERN TASARIMLAR	14 - 15
▶ KABİN MODELLERİ	16 - 29
▶ EK ÖZELLİKLER	30

PROLIFT
ELEVATOR

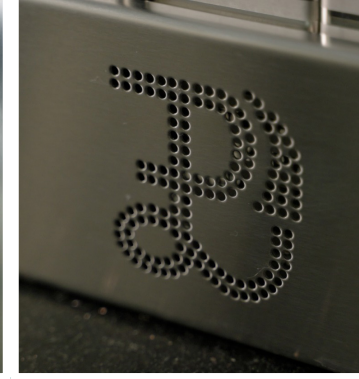

▶ ASANSÖR BUTONLARI

31

▶ ASANSÖR KAPILARI

32 - 33

▶ PERFORMANS, KALİTE VE KONFOR

34 - 35

▶ TEKNİK BİLGİLER

36 - 37

▶ DÜNYADA PROLİFT

38

▶ ULUSLARARASI STANDARTLAR

39

▶ SERTİFİKALAR

40 - 41

NEDEN PROLIFT ?

2002 yılında kurulan Prolift Asansör, toplamda 25.000m² kapalı alana sahip üretim tesisinde komple paket asansör üretimi yapmaktadır. Avrupa'nın en büyük entegre asansör üreticisi unvanına sahip olan Prolift, asansörü oluşturan parçaların %90'ını kendi bünyesinde üretmesi sebebiyle kısa termin süresi, müşterilerine hızlı geri dönüşü ve ürün kalitesini garanti ederek, müşterileri memnuniyetini sağlamaktadır. Prolift Asansör başta otomatik kat ve kabin kapıları olmak üzere kabin, süspansiyon, ağırlık karkası, makine şasesi, ray, hız regülatörü, fren, pano, buton ve motoru kendi bünyesinde üretmektedir.

AR-GE odaklı üretim çalışmalarıyla ürün çeşitliliğini sürekli geliştirerek, uzun ömürlü ve sorunsuz ürün kalitesine ulaşmayı başaran Prolift, AR-GE çalışmaları sonucunda, eksikleri daha iyi görebilmiş ve bu doğrultuda üretim yaparak müşteri memnuniyetini kazanmıştır. EN 81-20/ 50, EN 81-58 ve EN 81-70 uluslararası standartlara uygun üretilen asansörler, Avrupa ülkeleri başta olmak üzere Cezayir, Rusya, Suudi Arabistan ve Ukrayna için de gerekli olan tüm sertifikalandırma süreçlerinden geçmiş, ISO 9001 onaylı sertifikasıyla kalitesi onaylanmış, gelişen standart ve yönetmeliklere kısa sürede adapte oluşu ile müşteri memnuniyetini sağlamıştır.

Avrupa ülkeleri başta olmak üzere Amerika, Orta Asya, Orta Doğu ve Afrika kıtalarına satış yaparak toplamda 65 ülkeye ihracat yapmaktadır. Rusya ve Cezayir'de kendi markasına ait satış ofisi, deposu bulunan Prolift; Polonya, İspanya, Bulgaristan, Sırbistan, Meksika ve Türkiye'nin her bölgesinde bayilikleri bulunmaktadır.

Gelecek hedefi dünyanın en büyük entegre asansör üretim tesisi olmak olan Prolift, dünyada en çok tercih edilen dünya markası olma yolunda stratejiler geliştirmektedir.

EN 81-20/50
EN 81-70
ISO 9001
EAC



Tüm sertifikaları görmek için
proliftasansor.com.tr
web sitesini ziyaret ediniz.



PROLIFT

PROLIFT

PROLIFT

BMP-364 ile tanışın

BMP-364 asansörleri; konfor, kalite, tasarım ve güvenilirliği bir araya getirerek, yolcularına yepyeni bir deneyim sunmaktadır. BMP-364 asansörlerinde konfor ve sessizlik ön plana çıktığı gibi aynı zamanda birbirinden farklı kabin tasarım seçenekleriyle de memnuniyet sağlamaktadır. ISO 9001 sertifikalı, Avrupa standartlarına uygun üretilen BMP-364, güvenliği en üst seviyede tutmaktadır. Minimum seviyede bakım gerektiren tasarımı sayesinde binanıza değer katarak, zamandan tasarruf etmenizi sağlar.

BMP-364, kabin içi tasarımlarıyla modern bir çizgide ilerlerken konfor kalite ve performansı ön planda tutarak müşteri memnuniyetini ve güvenini kazanmıştır. Bu yüzden biz BMP-364 seri asansör modeli 3 konsept harmanlanarak tasarlanmıştır.



Konfor, Kalite ve Performansı



Güven ve Güvenilirlik



Tasarım

Bir Gün BAKIM

364
GÜN

Konforlu
Çalışma

A



3



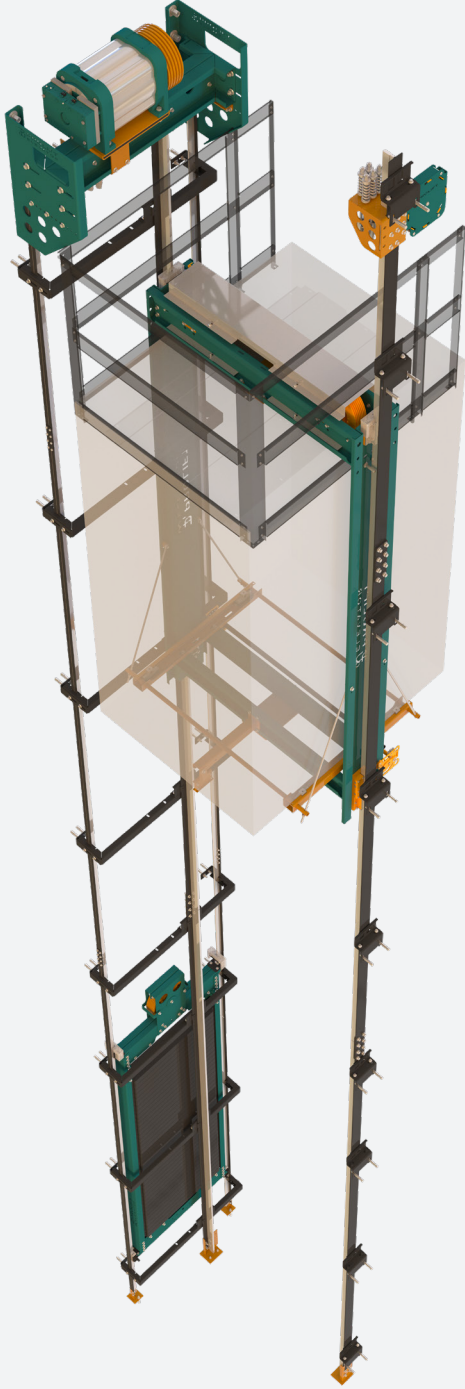

Genel Özellikler

YÜK	320-2000KG
KAPASİTE	4-26 Kişi
HIZ	0,75-1-1,6-2-2,5 M/S
MAX. SEYİR MESAFESİ	80 M
MİN SON KAT	3500MM
MİN KUYU DİBİ	1100MM
GİRİŞ	TEK/ÇİFT GİRİŞ
SİSTEM	MRL
PANO	PRL AKS SERİSİ
MAKİNA	PROLIFT
KAPI MODELİ	C SERİSİ, BİRÜNİ SERİSİ
KAPI GENİŞLİK	700-1600MM
KAPI YÜKSEKLİK	2000/2100/2200/2300

NOT: Verilen ölçüler projeye göre değişiklik gösterebilir.

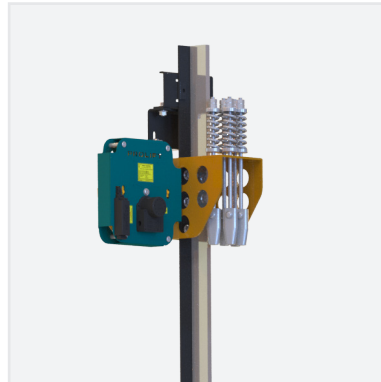
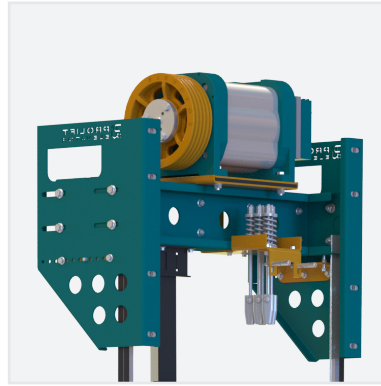

BMP-364 Table.1

KAPASİTE	KUYU GENİŞLİĞİ	KUYU DERİNLİĞİ	KABİN GENİŞLİĞİ	KABİN DERİNLİĞİ	SON KAT	KUYU DİBİ	KAPI GENİŞLİĞİ	HIZ
320	1400	1450	800	1100	3500	1100	700 2TP	0.75 - 1 - 1.2 - 1.6
450	1600	1700	1000	1100	3500	1100	800 2TP	0.75 - 1 - 1.2 - 1.6
630	1650	1800	1100	1400	3500	1100	900 2TP	0.75 - 1 - 1.2 - 1.6 - 1.75 - 2
800	1900	2000	1200	1500	3500	1200	900 2TP	0.75 - 1 - 1.2 - 1.6 - 1.75 - 2 - 2.5
1000	2000	2000	1400	1600	3500	1200	900 2TP	0.75 - 1 - 1.2 - 1.6 - 1.75 - 2 - 2.5
1250	2000	2500	1400	2100	3500	1300	1000 2TP	0.75 - 1 - 1.2 - 1.6 - 1.75 - 2 - 2.5
1600	2300	3000	1400	2400	3800	1500	1100 2TP	0.75 - 1 - 1.2 - 1.6 - 1.75 - 2 - 2.5
2000	2500	3400	1500	2800	3800	1500	1300 2TP	0.75 - 1 - 1.2 - 1.6 - 1.75 - 2 - 2.5

NOT: Verilen ölçüler projeye göre değişkenlik gösterebilir.

Layout

Tek Giriş

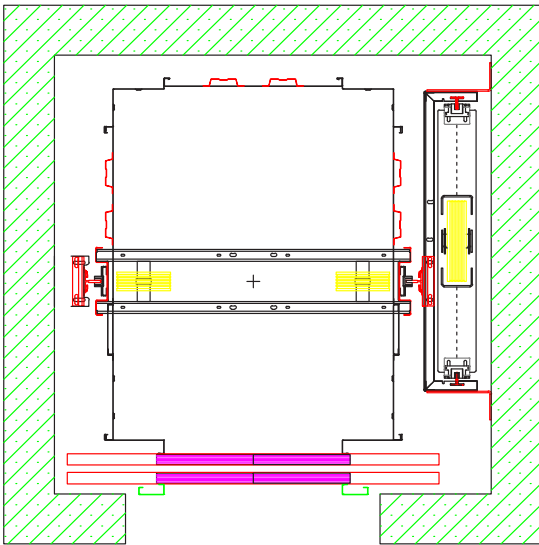

Çift Giriş

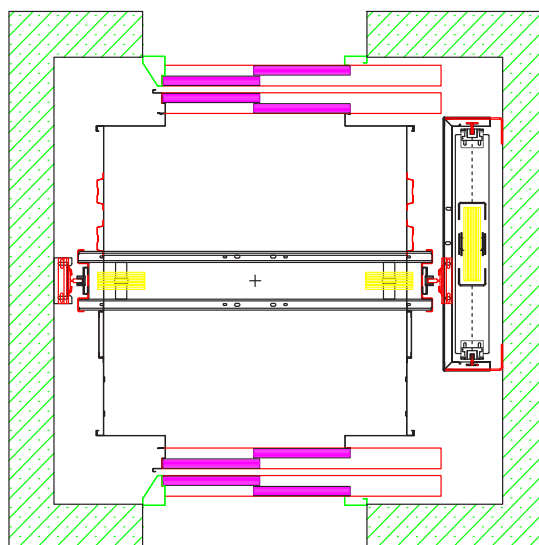

Dikey Kesit

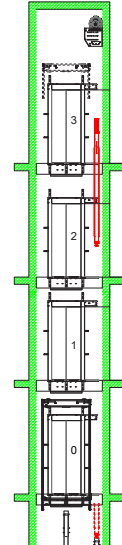





Güven ve Güvenilirlik

ISO 9001 sertifikalı üretim tesisimizde üretilen BMP-364, EN 81-20/50 ve EN 81-70 standartlarına uyum sağlamaktadır.

ACİL DURUMLAR

GÜÇ KESİNTİSİ

Otomatik kurtarma operasyon sistemi, yolcuları otomatik olarak en yakın kata güvenli bir şekilde ulaştırır. Elektrik kesintisi sırasında güvenli bir şekilde yolcuların tahli edilmesini sağlar.

YANGIN

Binanın yangın sensörü etkinleştğinde, asansör kabini daha önceden belirlenmiş olan bir kata döner ve yolcuların güvenli bir şekilde tahliye edilmesi için kapılar açık bir şekilde bekler. Yolcular tahliye edildikten sonra asansör hiçbir çağrıyı kabul etmez.

DEPREM

Deprem sismik sensörü etkinleştğinde, asansör kabini en yakın kata gelerek kapıları açık bir şekilde bekler. Bu sayede yolcular güvenli bir şekilde tahliye edilmiş olur. Yolcular tahliye edildikten sonra asansör hiçbir çağrıyı kabul etmez.

UCMP

Asansör kabinin istenmeyen hareketi, güvenlik amaçlı bağımsız bir kontrol devresi tarafından algılanır. Bu işlev yolcuların güvenliğini artırır.

HABERLEŞME SİSTEMİ (3 YÖNLÜ)

Asansör haberleşme sistemleri; asansör içerisinde bulunan merkezi sistem ile binada bulunan görevliyle veya çağrı merkezi ile otomatik bağlantı sağlayarak acil durumlarda iletişimi sağlamaya yardımcı olan sistemlerdir. Özellikle görevli olmayan binalarda meydana gelebilecek asansör sorunlarında teknik personelin olay yerine yönlendirilmesini sağlar.

MINIMALIST



Modern Tasarımlar

Toplu konut binaları, oteller, havaalanları, metro istasyonları, hastaneler gibi tüm projelerinizin konseptlerine uygun tasarlanmış birçok modern ve şık kabin seçenekleri sunuyoruz.

Modern ve şık kabin tasarımları arasından dilediğinizi seçebilme imkanı sağlarken, geniş malzeme yelpazesi sayesinde sizin zevkinize uygun kabininizi tasarlama imkanı sağlıyoruz.

Her binanın kullanım amacına göre özelleştirilebilen kabin seçeneklerimizle hayal ettiğiniz tasarımı sizler için hayata geçiriyoruz. Sizlere tasarım özgürlüğü sunarak; kabinler, geniş malzeme, aydınlatma, zemin ve aksesuar opsiyonlarıyla eşsiz tasarımınızı oluşturmanıza olanak sağlıyor, binanıza değer katıyoruz.

**SİZE
UYGUN
KABİN
TASARIMINI
SEÇİN**

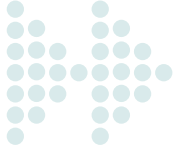

KAPLAMA
Satine Paslanmaz



TAVAN
Satine Paslanmaz
Lazer Kesim



TABAN
Doğal Granit



AKSESUAR
Satine Paslanmaz



KÜPEŞTE
Çift Sıra Paslanmaz



AYNA
Tam Boy



OPSIYONEL

→ Tavan



→ Taban



→ Kaplama



→ Küpeşte

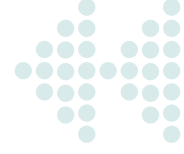

**KAPLAMA**

Dekoratif Paslanmaz

**TAVAN**Satine Paslanmaz
Lazer Kesim**TABAN**

Granit

**AKSESUAR**

Satine Paslanmaz

**KÜPEŞTE**

Çift Sıra Küpeşte

**AYNA**

Tam Boy

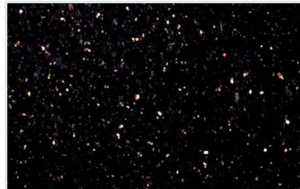
OPSIYONEL**Tavan****Taban****Kaplama****Küpeşte**

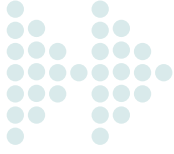

KAPLAMA
Satine Paslanmaz



TAVAN
Satine Paslanmaz
Lazer Kesim



TABAN
Granit



AKSESUAR
Cam



KÜPEŞTE
Üç Sıra Paslanmaz



OPSIYONEL

→ Tavan



→ Taban

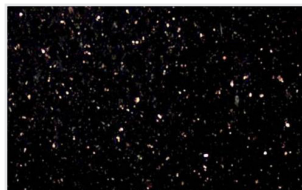

→ Kaplama



→ Küpeşte



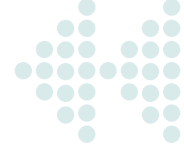

KAPLAMA
Dekoratif Sac



TAVAN
Satine Paslanmaz
Lazer Kesim



TABAN
Doğal Granit



AKSESUAR
Satine Paslanmaz



KÜPEŞTE
Çift Sıra Paslanmaz



AYNA
Tam Boy

OPSIYONEL

→ Tavan



→ Taban



→ Kaplama

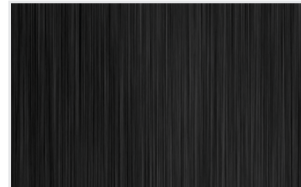

→ Küpeşte



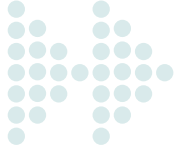

KAPLAMA
Elektrostatik Boyalı



TAVAN
Elektrostatik Boyalı
Lazer Kesim



TABAN
PVC Kaplama



AKSESUAR
Elektrostatik Boyalı



KÜPEŞTE
Çift Sıra Paslanmaz



AYNA
Tam Boy



OPSIYONEL

→ Tavan



→ Taban



→ Kaplama



→ Küpeşte





KAPLAMA

Dikey Satine Paslanmaz



TAVAN

Lazer Kesim



TABAN

Alüminyum Çeta



AKSESUAR

Satine Paslanmaz



KÜPEŞTE

Çift Sıra Paslanmaz



AYNA

Tam Boy

OPSIYONEL

→ Tavan



→ Taban



→ Kaplama



→ Küpeşte





KAPLAMA
Elektrostatik Boya



TAVAN
Spot Aydınlatma



TABAN
Desenli Sac



AKSESUAR
Çift Sıra
Çarpma Bandı,
Tahliye Kapağı ve
Merdiven



OPSIYONEL

→ Tavan

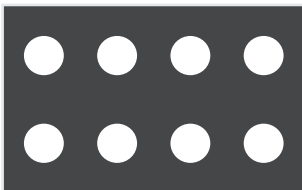

→ Taban

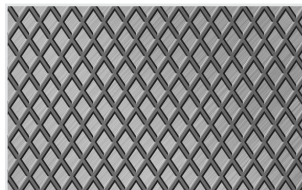

→ Kaplama



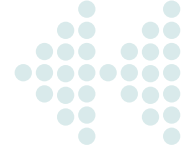

KAPLAMA

Dekoratif Paslanmaz



TAVAN

Satine Paslanmaz
Lazer Kesim



TABAN

Kuvars



AKSESUAR

Satine Paslanmaz



KÜPEŞTE

Çift Sıra Küpeşte



AYNA

Tam Boy (LCD ekranlı)

OPSIYONEL

→ Tavan

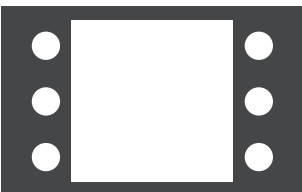

→ Taban



→ Kaplama

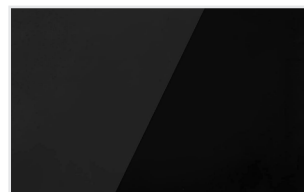

→ Küpeşte





KAPLAMA
Satine Paslanmaz



TAVAN
Satine Paslanmaz
Lazer Kesim



TABAN
Granit



AKSESUAR
Cam



KÜPEŞTE
Çift Sıra Küpeşte



OPSIYONEL

→ Tavan



→ Taban

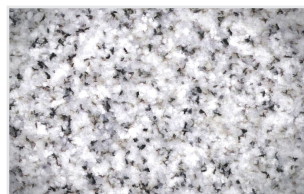

→ Kaplama



→ Küpeşte

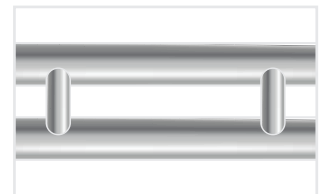

Kabininizi Tasarlayın

Size uygun renk ve deseni belirleyin

PANEL KAPLAMA

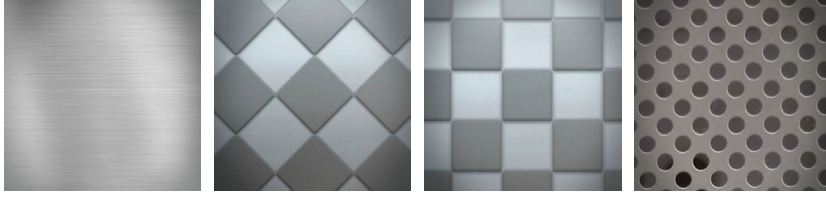

PRL-P01

PRL-P02

PRL-P04

PRL-P05



PRL-P06

PRL-P07

PRL-P08

PRL-P09

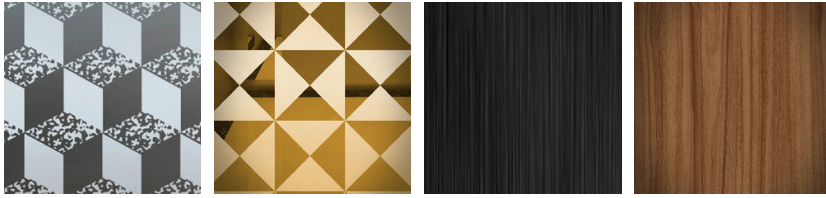

PRL-P10

PRL-P11

PRL-P12

PRL-P13

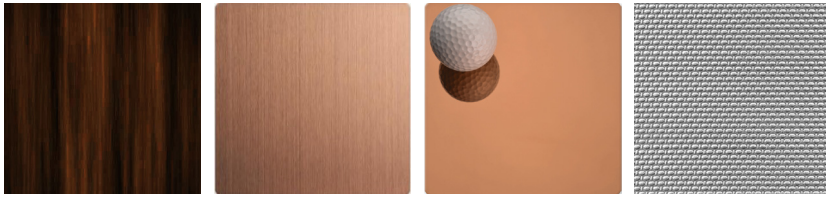

PRL-P14

PRL-P23

PRL-P24 (AYNA)

PRL-P25

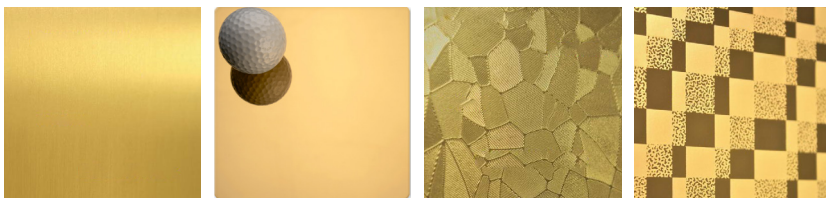

PRL-P26

PRL-P27 (AYNA)

PRL-P28

PRL-P29

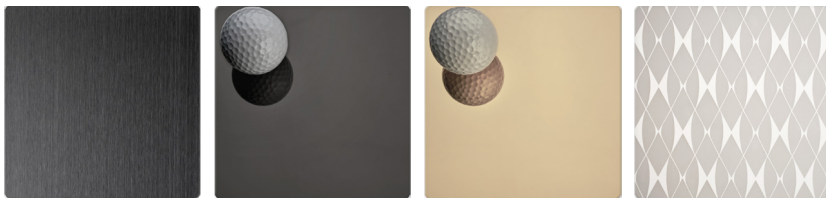

PRL-P30

PRL-P31 (AYNA)

PRL-P32 (AYNA)

PRL-P33



PRL-P34

PRL-P35 (AYNA)

PRL-P36 (AYNA)

PRL-P37 (AYNA)

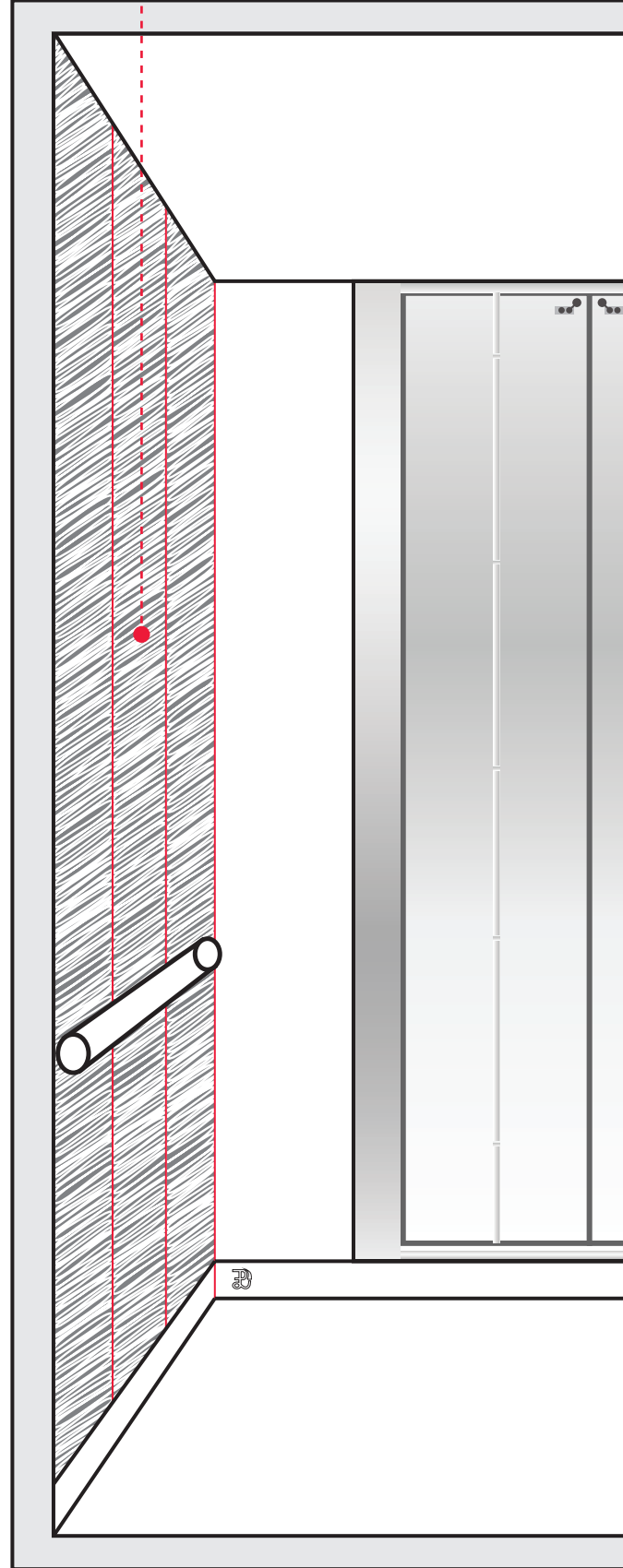

Her proje için özelleştirilebilen farklı kabin seçenekleri ile tasarım deneyimini yaşayın.

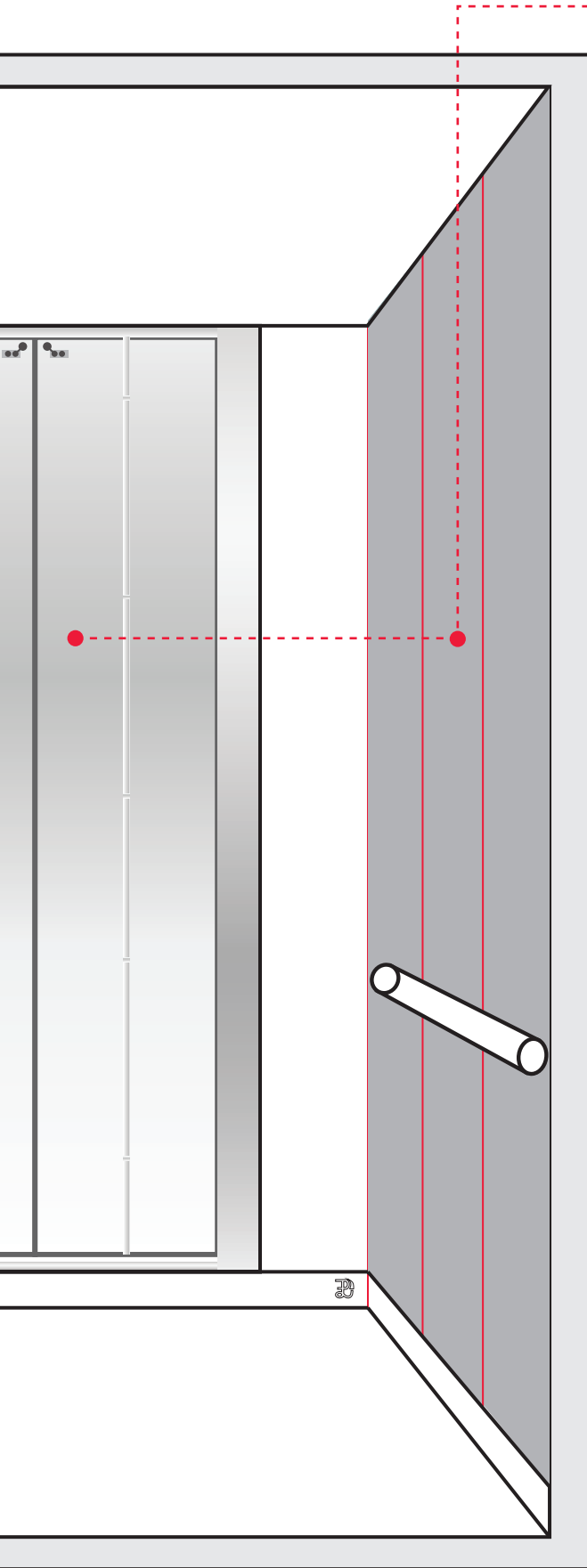

BOYA SEÇENEKLERİ

			
RAL 9006	RAL 7032	RAL 7035	RAL 5005
			
RAL 2011	RAL 9005	RAL 7008	RAL 5010
			
RAL 7040	RAL 7033	RAL 7034	RAL 7035
			
RAL 8001	RAL 8002	RAL 8003	RAL 8004
			
RAL 7008	RAL 7011	RAL 7013	RAL 7021
			
RAL 7022	RAL 1023	RAL 6016	RAL 5001
			
RAL 9016	RAL 3028	RAL 3001	RAL 4011

Aksesuarlarla Ssleyin

TAVAN | Lazer Kesim Satine Paslanmaz



PRL-T01

PRL-T02

PRL-T04

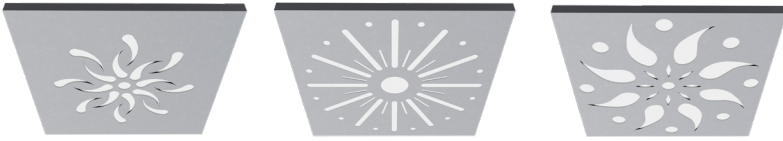

PRL-T07

PRL-T10

PRL-T11



PRL-T12

PRL-T15

PRL-T16



PRL-T18

PRL-T19

PRL-T22



PRL-T28

PRL-T29

PRL-T30

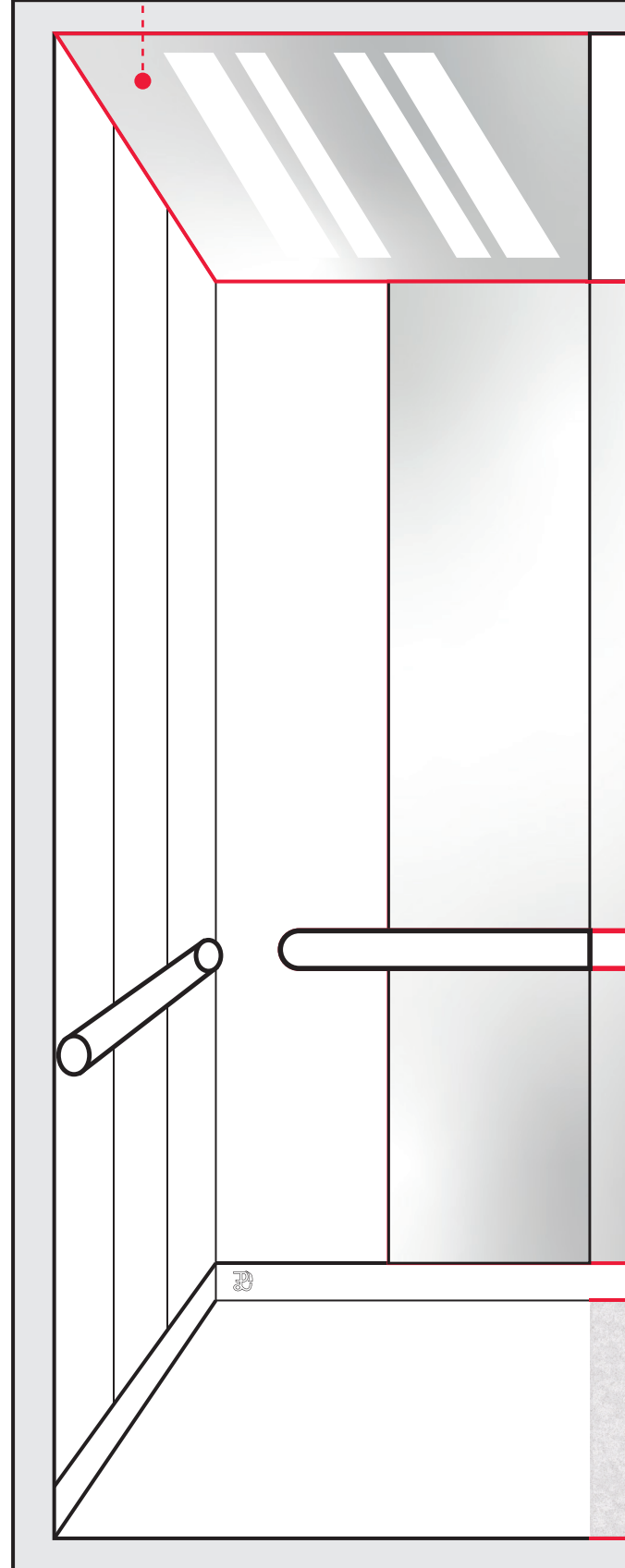

Her proje için özelleştirilebilen farklı kabin seçenekleri ile tasarım deneyimini yaşayın.

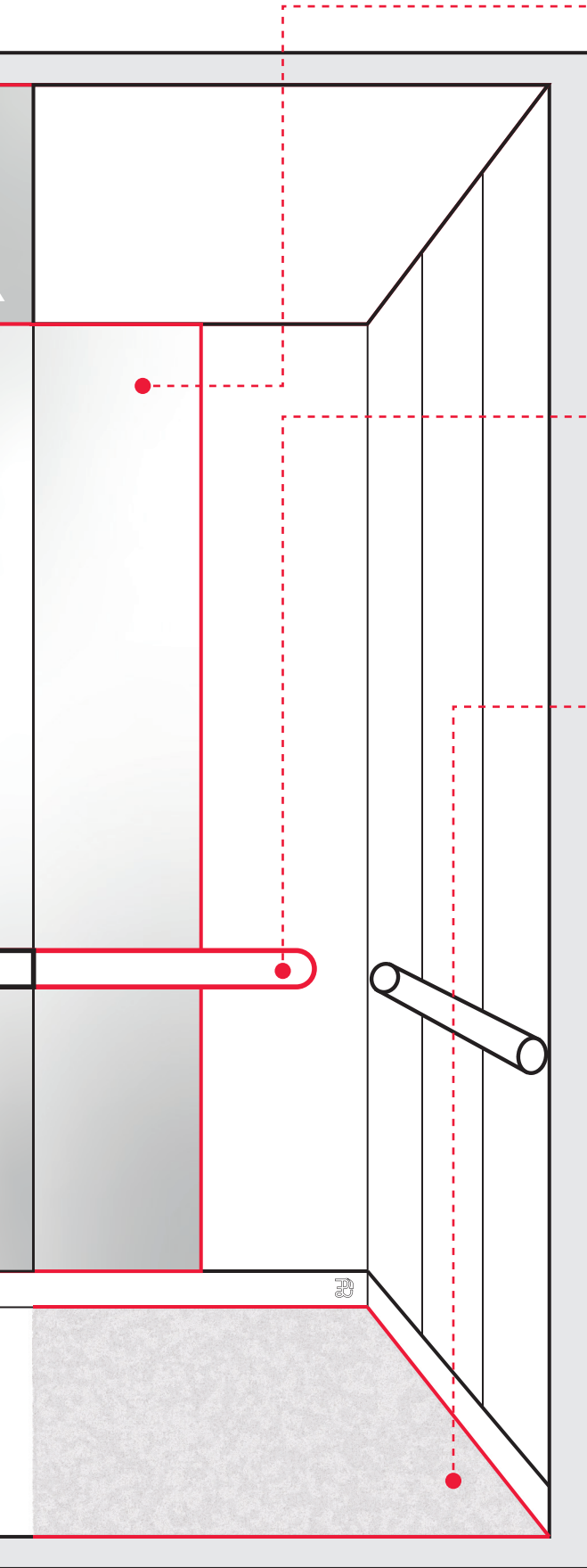

AYNA

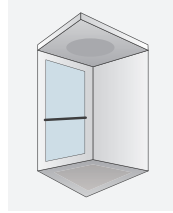

TAM BOY
AYNA
PRL-A01

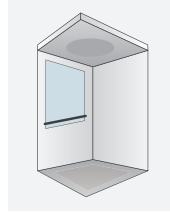

YARIM BOY
AYNA
PRL-A02

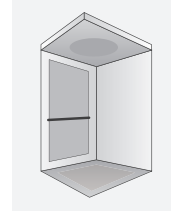

SÜPER AYNA
(PASLANMAZ)
PRL-A03

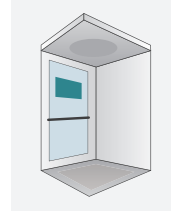

TELEVİZYONLU
AYNA
PRL-A04

KÜPEŞTE

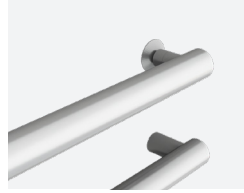

PRL-H01

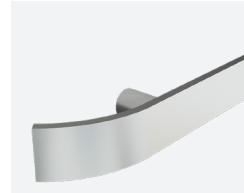

PRL-H02



PRL-H03

TABAN KAPLAMA

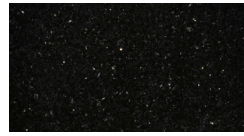

PRL-Z01

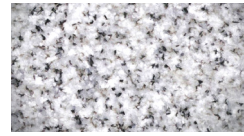

PRL-Z02

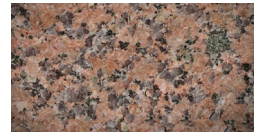

PRL-Z03

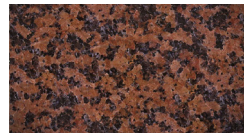

PRL-Z04



PRL-Z05

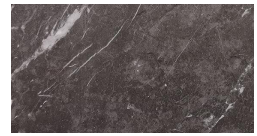

PRL-Z11 (PVC)

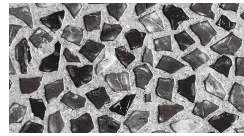

PRL-Z12 (PVC)



PRL-Z13 (PVC)



PRL-Z14

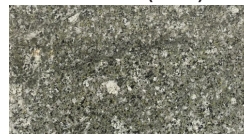

PRL-Z15



PRL-Z16



PRL-Z17 (PVC)

EK SEÇENEKLER

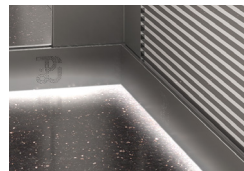

İŞIKLANDIRMA



MERDİVEN



ÇARPMA BANDI



KART OKUYUCU SİSTEM



Asansör kat yetkilendirme sistemleri, herkesin her kata çıkmasını istemediğimiz durumlarda kullanılan bir geçiş kontrol sistemidir.

Asansör kat yetkilendirme sistemi ile kartları kişiler için özelleştirebiliriz bu sistemler ile yetkilendirilmiş kartlar sadece yetkisi olan katlara çıkar. Asansör kat yetkilendirme sistemleri belediye, adliye, hastane, okul gibi insan yoğunluğunun çok olduğu yerlerde oldukça sık kullanılan bir sistemdir.



ASANSÖR KAMERA



Asansör kabin içi güvenlik önlemi olarak, güvenlik kamera sistemi kurulması en önemli ihtiyaçlardandır. Kamera ile görüntü kaydı alınabildiği gibi anlık izleme de sağlanabilir.



PARMAK İZİ OKUYUCU SİSTEM



Asansör parmak izi okuyucu sistem, sadece kayıtlı kişilerin asansörü kullanılması istenildiği durumlarda kullanılan bir geçiş kontrol sistemidir. Asansör parmak izi okuyucu sistemi ile kartları kişiler için özelleştirebiliriz. Bu sayede sadece yetkisi olanlar katlara çıkar. Asansör kat yetkilendirme sistemleri okul, iş yerleri, ticari binalar ve belediyeler gibi insan yoğunluğunun çok olduğu yerlerde oldukça sık kullanılan bir sistemdir.



PRL-B13-E SERİSİ

- ▶ Buton metal parçalarının tamamı korozyona karşı dekoratif kaplamalı çelikten imal edilmiştir.
- ▶ İstenilen renk ve desende ki paslanmaz sacdan veya boyalı olarak üretilebilir.
- ▶ Uzun ömürlüdür.
- ▶ Darbelere karşı dayanıklıdır.
- ▶ Kat butonları, kızaklı montaj kiti sayesinde kolay montaj edilir ve kapak montajı için vida gerektirmez.
- ▶ 7-segment olarak yarım veya tam boy olarak üretilebilmektedir.

PRL-B13-L SERİSİ

- ▶ EN 81-70 ve EN 81-20 uluslararası standartlarla uyumludur.
- ▶ Anons sistemi ve video oynatabilme özelliği bulunmaktadır.
- ▶ Her kata özel tanımlanan resim veya video seçeneği bulunmaktadır.
- ▶ Entegre çift yönlü haberleşme sistemi mevcuttur.
- ▶ Acil durum aydınlatma sistemi vardır.
- ▶ Müşteri isteğine özel lazer markalama yapılabilir.

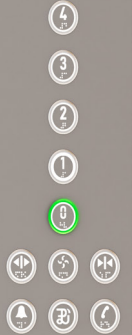



MODEL
C SERİSİ/BİRÜNİ

KAPLAMA
SST

OPSİYONEL

PANEL SAYISI
2

YANGIN SINIFI
E-120, EW-60,EI-120

KULLANIM ALANI
KONUT BİNALARI
HASTANE, TİCARİ
BİNA VB.



MODEL
C SERİSİ

KAPLAMA
SST

OPSİYONEL

PANEL SAYISI
3

KULLANIM ALANI
HASTANE, TİCARİ BİNA,
KONUT BİNALARI VB.



OPSİYONEL

MODEL
C SERİSİ

KAPLAMA
SST

PANEL SAYISI
4

KULLANIM ALANI
HASTANE, İŞ YERLERİ VB.



OPSİYONEL

MODEL
C SERİSİ

KAPLAMA
SST

PANEL SAYISI
6

KULLANIM ALANI
HASTANE, DEPO VB.





OPSİYONEL

MODEL
C SERİSİ/BİRÜNİ

KAPLAMA
DEKORATİF PVC SAC

PANEL SAYISI
2

YANGIN SINIFI
E-120, EI-120, EW-60

KULLANIM ALANI
KONUT BİNALARI,
İŞ YERLERİ VB.



OPSİYONEL

MODEL
C SERİSİ/BİRÜNİ

KAPLAMA
DEKORATİF

PANEL SAYISI
2

YANGIN SINIFI
E-120, EI-120, EW-60

KULLANIM ALANI
KONUT BİNALARI
HASTANE, TİCARİ
BİNA VB.



OPSİYONEL

MODEL
C SERİSİ/BİRÜNİ

KAPLAMA
CAM SST

YANGIN SINIFI
E-30 , EW-30

KULLANIM ALANI
KONUT BİNALARI
ALIŞVERİŞ MERKEZLERİ,
ÖZEL MÜLK VB.



OPSİYONEL

MODEL
C SERİSİ/BİRÜNİ

KAPLAMA
ESB BOYALI

YANGIN SINIFI
E-120, EI-120, EW-60

KULLANIM ALANI
KONUT BİNALARI,
İŞ YERLERİ VB.

Genel Özellikler

- İsteğe bağlı olarak farklı dekoratif desen ve renklerde üretilebilirlik
- "E" sınıfı (yangına dayanıklı), "EW" sınıfı (sınırlı ışınlamaya sahip) EI" sınıfı (yangın kesme) yangına dayanıklı kapılar
- 2,3,4 ve 6 panel Vandalizme dayanıklı EN 81-71 uyumlu asansör kapıları
- Yüksek hızlı ve trafiği yoğun asansörlerde erken açma özelliği uyumlu hale getirebilme
- Sessiz ve uzun ömürlü sorunsuz çalışma

Yüksek
Verimlilik

Çevreci ve
Ekonomik

Ses
Yalıtımı

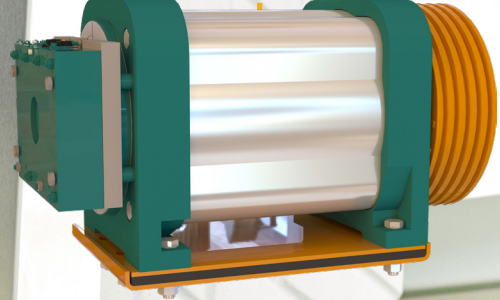

PERFORMANS KALİTE VE KONFOR

İnsanların güvenli ve sorunsuz hareket etmesini sağlamak için ne gerektiğini biliyoruz. Binanızı kendimizin gibi görüyor ve en iyi hizmeti sağlamak için her gün kendimizi geliştiriyoruz.

Bir asansörde konfor sağlayan etkenlerin ses, titreşim ve asansör seviyelemesinin uygun şekilde olması gerektiğini biliyor, ürünlerimizi buna göre tasarlıyoruz.

Bmp-364 asansör sistemlerini de; titreşim takozu monte edilmiş dişlisiz motoru, kumanda panosu, rayları, yüksek-performanslı sessiz çalışan kapıları ve ses yalıtım izolasyonlarıyla donatılmış kabini sayesinde, kullanıcılarına sessiz ve konforlu bir yolculuk deneyimi yaşatmak için tasarladık.



GENEL ÖZELLİKLER

TİP:	MRL
ASKI TİPİ:	2/1
YÜK:	320-2000KG
KAPASİTE:	4-26 Kişi
HIZ:	1.0-1,6-2-2,5 M/S
SEYİR MESAFESİ:	MAX: 80M
DURAK SAYISI:	25
GİRİŞ:	TEK VE ÇİFT GİRİŞLİ
KUYU ÖLÇÜLERİ:	TABLO.1 BAKINIZ
SON KAT:	TABLO.1 BAKINIZ
KUYU DİBİ:	TABLO.1 BAKINIZ

KABİN BUTONU

KABİN KASEDİ MODEL :	PROLIFT L SERİSİ TAM BOY
KABİN KASEDİ KAPLAMASI:	SATİNE *OPSİYONEL
KABİN KASEDİ TİPİ:	SIVA ALTI
GÖSTERGE:	7 SEGMENT
GÜVENLİK EKİPMANLARI:	İNTERKOM/ ÜÇ YÖNLÜ HABERLEŞME SİSTEMİ
ACİL DURUM AYDINL:	DAHİL
ALARM:	DAHİL
SESLİ ANONS:	DAHİL

KABİN KAPISI

KABİN KAPISI MODELİ:	PROLIFT C-250 / BİRÜNİ
KABİN KAPISI TİPİ:	PROLİFT OTOMATİK 2 PNL MERKEZ/TELESKOPIK, 3 PNL TELESKOPIK, 4 PNL MERKEZ, 6 PNL MERKEZ KAPI AÇILIMI İSTEĞE BAĞLI: DİĞER MODELLER
KAPLAMA:	304 SATİNE PASLANMAZ *OPSİYONEL
ÖLÇÜLER:	TABLO.1 BAKINIZ
KABİN KAPISI GEN:	TABLO.1 BAKINIZ
KABİN KAPISI YÜK:	TABLO.1 BAKINIZ

KABİN MODELİ

MODEL:	AKHAL TEKE SB
KABİN İÇ GENİŞLİK:	TABLO.1 BAKINIZ
KABİN İÇ DERİNLİK:	TABLO.1 BAKINIZ
KABİN İÇ YÜKSEKLİK:	TABLO.1 BAKINIZ
TAVAN DEKORASYONU:	SATİNE
DUVAR MALZEMESİ:	PASLANMAZ
DUVAR DEKORASYONU:	SATİNE
AYDINLATMA:	İNDİREKT
SÜPÜRGELİK:	SATİNE
KÜPEŞTE TİPİ & KAPLAMASI:	DÜZ & SATİNE
KÜPEŞTE:	ARKA DUVARDA ÇİFT SIRA
Opsiyonel: Farklı kabin tasarımları, katalogtan inceleyiniz.	

KAT BUTONU

KAT KASEDİ MODEL:	PRL B-13
KAT KASEDİ PANELİ:	GÖSTERGELİ
KAT KASEDİ KAPLAMASI:	SATİNE
KAT KASEDİ TİPİ:	SIVA ÜSTÜ
KAT GÖSTERGE PANELİ:	7 SEGMENT

KAT KAPISI

KAT KAPISI MODEL:	PROLIFT C-150
KAT KAPISI TİPİ:	PROLİFT OTOMATİK 2 PNL MERKEZ/TELESKOPIK, 3 PNL TELESKOPIK, 4 PNL MERKEZ, 6 PNL MERKEZ KAPI AÇILIMI İSTEĞE BAĞLI: DİĞER MODELLER
KAPI KAPLAMASI:	SATİNE PASLANMAZ *OPSİYONEL
YANGIN SINIFI:	E-120, EW-60 (OPSİYONEL: DİĞER SINIFLAR: EI-120)
KAT KAPISI GEN:	TABLO.1 BAKINIZ
KAT KAPISI YÜK:	TABLO.1 BAKINIZ
KAPI KASA ÖLÇÜLERİ:	100 (YAN) 150 (ÜST) MM

PANO

MARKA:	PRL AKS SERİSİ(ARKEL,MİKEL)
BAĞLANTI TİPİ:	HAZIR TESİSAT
REVİZYON KUTUSU:	DAHİL
KUMANDA PANOSU KAPLI:	RALL 7032/OPSİYONEL: DİĞER RENKLER VE PASLANMAZ
KUMANDA PANOSU YERİ:	SON KAT KAPISI YANI
EL TERMİNALİ:	DAHİL
OTO. KURTARMA AYGITI:	DAHİL

MAKİNE VE HIZ REGÜLATÖRÜ

MAKİNE MODEL :	OPSİYONEL
MAKİNE TİPİ:	DİŞLİSİZ
HALAT:	6,5 MM - 8 MM
HIZ REGÜLATÖRÜ MODELİ:	PRL RG - 247
HIZ REGÜLATÖRÜ TİPİ:	RAY TİPİ
HALAT:	6 MM

ANA RAY VE KARŞI AĞIRLIK RAYI

50X50X9:	ROLLFORM ÇEKME
70X65X9MM:	SOĞUK ÇEKME
89X62X16MM :	SOĞUK ÇEKME
90X75X16MM:	SOĞUK ÇEKME

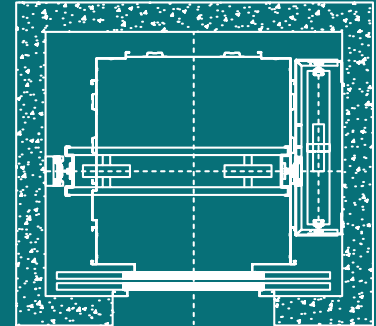
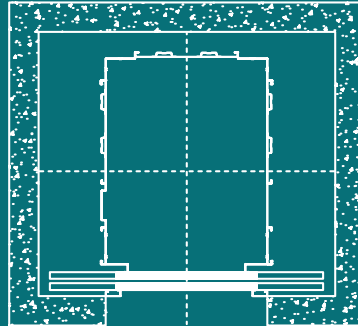
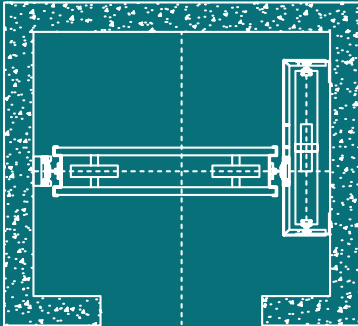
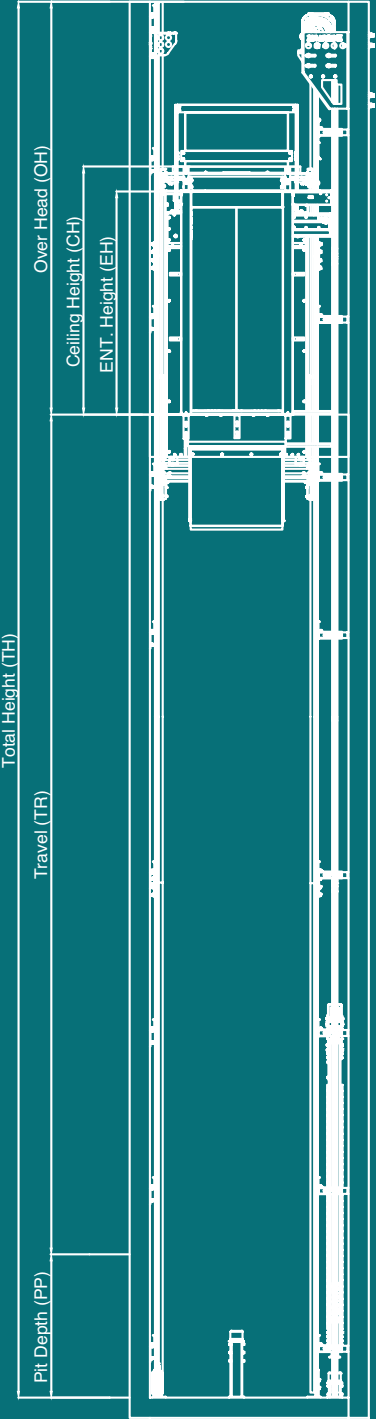

DÜNYADA PROLIFT

- ▶ ALMANYA
- ▶ ARJANTİN
- ▶ ARNAVUTLUK
- ▶ AVUSTRALYA
- ▶ AZERBAYCAN
- ▶ B. HERSEK
- ▶ BEYAZ RUSYA
- ▶ BULGARİSTAN
- ▶ CEZAYİR
- ▶ ÇEK CUMHURİYETİ
- ▶ DANİMARKA
- ▶ ERMENİSTAN

- ▶ FAS
- ▶ FRANSA
- ▶ GİNE
- ▶ GÜRCİSTAN
- ▶ HIRVATİSTAN
- ▶ HİNDİSTAN
- ▶ HOLLANDA
- ▶ İRAN
- ▶ İSPANYA
- ▶ İTALYA
- ▶ KATAR
- ▶ KAZAKİSTAN

- ▶ KIRGIZİSTAN
- ▶ KOSOVA
- ▶ LETONYA
- ▶ LÜBNAN
- ▶ MACARİSTAN
- ▶ MAKEDONYA
- ▶ MALI
- ▶ MALTA
- ▶ MEKSİKA
- ▶ MOLDOVA
- ▶ NİJERYA
- ▶ ÖZBEKİSTAN

- ▶ POLONYA
- ▶ ROMANYA
- ▶ RUSYA
- ▶ SİRBİSTAN
- ▶ SLOVENYA
- ▶ SUDAN
- ▶ SUUDİ ARABİSTAN
- ▶ TUNUS
- ▶ UKRAYNA
- ▶ YENİ ZELANDA
- ▶ YUNANİSTAN



ULUSLARARASI STANDARTLAR

AVRUPA

•••
EN 81-20
EN 81-50
EN 81-28
EN 81-58
EN 81-70
EN 81-71

RUSYA

•••
GOST-R
EAC

CEZAYİR

•••
ENACT

UKRAYNA

•••
UKR-SEPRO

NİJERYA

•••
SONCAP

SUUDİ ARABİSTAN

•••
SASO

ЕВРАЗИЙСКИЙ ЭКОНОМИЧЕСКИЙ СОЮЗ
СЕРТИФИКАТ СООТВЕТСТВИЯ
№ EACSR RU CTR 18068 B 0042921
Серия RU № 02307973

INTERNATIONAL FIRST CERTIFICATION
CERTIFICATE
This certificate,
PROLIFT ASANSÖR SAN. VE TİC. A.Ş.
INTERNATIONAL BUSINESS

TYPE EXAMINATION CERTIFICATE
FOR LIFTCOMPONENTS
Description of the product
No: NL16-400-100-110 Rev.2

LIFTINSTITUUT
TYPE EXAMINATION CERTIFICATE
FIRE RESISTANCE OF LIFTS LANDING DOORS
Certificate no: NL16-400-100-110-19 Revision no: 1

TYPE EXAMINATION CERTIFICATE
FIRE RESISTANCE OF LIFTS LANDING DOORS
Description of the product
No: NL16-400-100-110-19 Revision no: 2

TYPE EXAMINATION CERTIFICATE
FIRE RESISTANCE OF LIFTS LANDING DOORS
Description of the product
No: NL12-400-100-110-06 Revision no: 2

ТАМОНЕННЪ СОЮЗ
СЕРТИФИКАТ СООТВЕТСТВИЯ
№ EACSR RU CTR 18068 B 1867

EU TYPE EXAMINATION CERTIFICATE
PROLIFT ASANSÖR SAN. VE TİC. A.Ş.
DİŞARZI GÜVENLİK TEST VE BEĞERENLERİNE TİC. LİSİ.

EU TYPE EXAMINATION CERTIFICATE
PROLIFT ASANSÖR SAN. VE TİC. A.Ş.
DİŞARZI GÜVENLİK TEST VE BEĞERENLERİNE TİC. LİSİ.

EU-TYPE EXAMINATION CERTIFICATE
PROLIFT ASANSÖR SAN. VE TİC. A.Ş.
Description of the product
No: NL16-400-100-110-19 Rev.2

EU TYPE EXAMINATION CERTIFICATE
PROLIFT ASANSÖR SAN. VE TİC. A.Ş.
No: LD01-0806-0054-19 Rev05

TYPE EXAMINATION CERTIFICATE
FIRE RESISTANCE OF LIFTS LANDING DOORS
Description of the product
No: NL16-400-100-110-19 Revision no: 2



P **PROLIFT**
ELEVATOR
BMP-364

ProManner ProService Prolift

PROLIFT ASANSÖR SAN. TİC. A.Ş



Büyükbalklı Mah. Büyükbalklı Cad.
No:157/A-157/B Nilüfer/BURSA



+90 444 21 70



info@proliftasansor.com.tr



+90 224 443 28 49



proliftasansor.com.tr

